

MR-PROM

REFRIGERATED OPEN MERCHANDISER

DESCRIPTION OF STANDARD UNIT:

- Construction of powder-coated steel
- LED lighting
- ABS sides with glass
- Grey bumper
- 4 rows of adjustable shelves
- Top lighting
- Light plafond
- White lighting
- Night blind
- Price strips
- Forced cooling
- Temp. range*: 0 ÷ +4°C
- Automatic defrosting
- Digital temperature control



Baskets not included

OPTIONS:

- Multiplexing
- For external condensing unit
- Highlighted shelves
- Stainless steel shelves & base decks
- Back panel from mirrored stainless steel
- Angled mirrored stainless steel roof
- Stoppers: wired or from Plexiglas
- Shelf separators (wired)
- Profile with hooks
- Wood casing
- Wheels
- Heater under evaporator
- Automatic water Evaporation

SPECIFICATIONS

MODEL	LENGTH	DEPTH	HEIGHT	WEIGHT (LBS / KG)	ELECTRICAL
MR3-PROM	43 1/4"	34 1/8"	81"	418 / 190	115V / 60Hz / 1ph / 15 AMP
MR4-PROM	51 1/8"			514 / 233	115V / 60Hz / 1ph / 15 AMP
MR5-PROM	63"			641 / 291	220V / 60Hz / 1ph / 15 AMP
MR6-PROM	74 7/8"			771 / 350	220V / 60Hz / 1ph / 11 AMP
MR7-PROM	81 3/4"			899 / 408	220V / 60Hz / 1ph / 13 AMP

* Temperature range given for maximum ambient temperature of +25°C and relative humidity 60%.

** Cooling power demand: 1500 W/1m² at evaporating temp. -10°C. Automatic water evaporation on request.

*** In version with doors: only top lighting

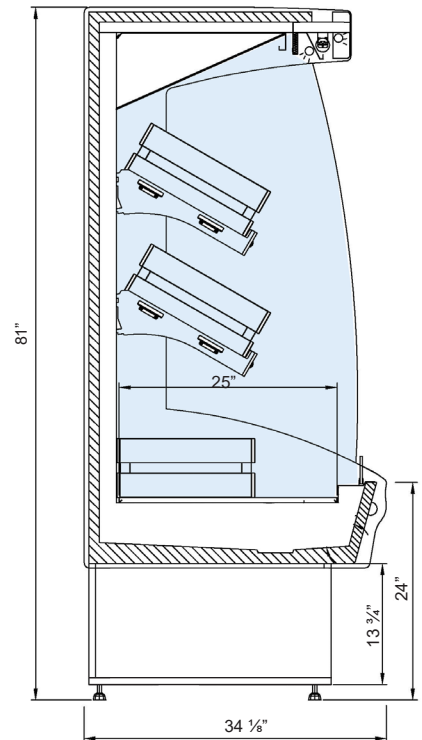

Wood Stains

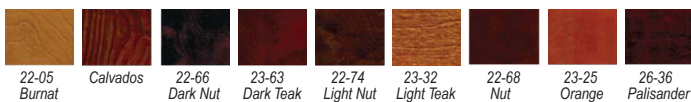

Available Colors

